

Anti-Bacterial Protection

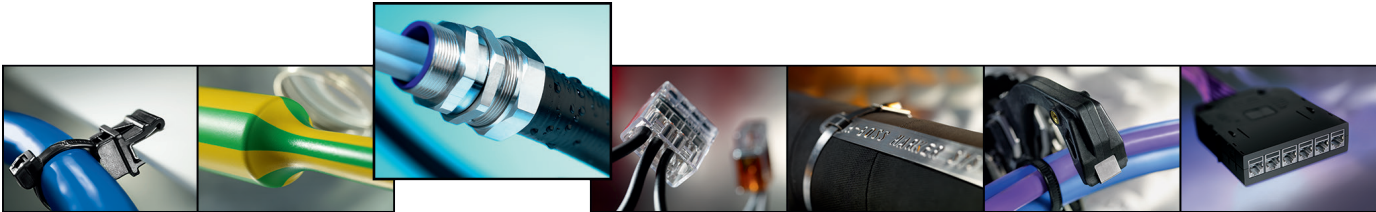

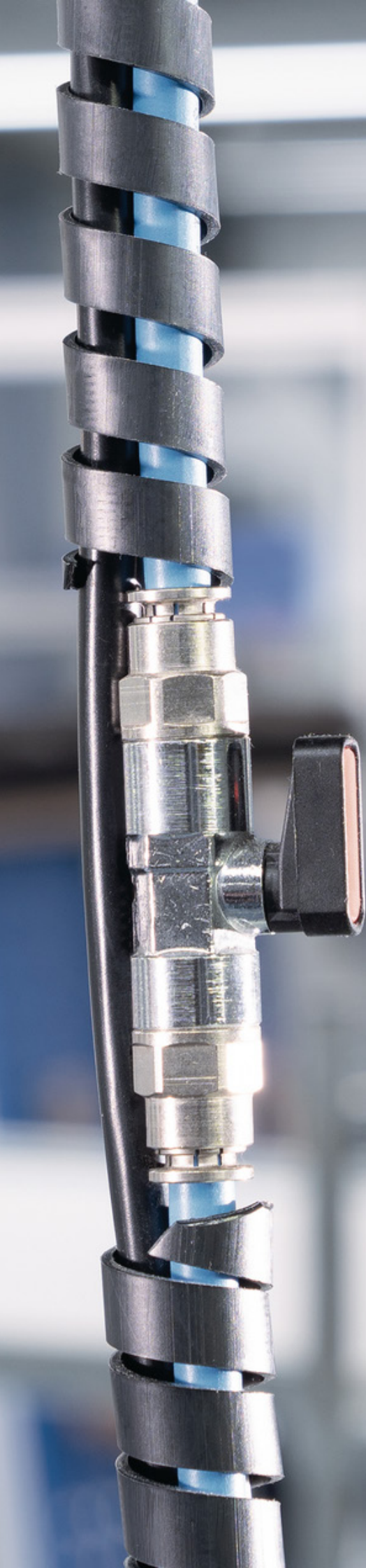

## Anti-Bacterial Properties

Covid 19 has meant an ever changing market for our customers. At HellermannTyton we pride ourselves in providing solutions to meet our customers' needs and this current situation has been no different.

At the start of the pandemic we worked with our key suppliers to provide material ranges that are resistant to bacterial growth.

### What does that mean?

Our product ranges of **Spiral Binding, Helawrap, FCT** and **Grommet Strip** are now available with an additive that gives the plastic **anti-bacterial properties**. Laboratory tests have demonstrated that these products are 99.9% effective in preventing the survival or growth of bacteria on their surfaces. Specific tests were carried out on MRSA and E. Coli which are well known pathogens.

E. Coli (Escherichia Coli) can cause illness in humans. This bacteria has the potential to cause infection even if you ingest only small amounts. Potential sources of exposure include contaminated food or water and person-to-person contact.

MRSA Methicillin-resistant Staphylococcus aureus refer to a group of bacteria that are generally resistant to some antibiotics. Generally they do not cause any harm however can cause skin infections and in some cases pneumonia.

HellermannTyton's Anti-Bacterial range provides protection against all bacteria, as they will not survive on the surface of the product. This is especially important in hard to reach places, particularly in environments where cleanliness and the prevention of contamination is crucial.



## Helawrap Cable Cover

### HWPPAB: Anti-Bacterial Helawrap

The HWPPAB range of flexible harness protection is designed to protect cables when routed through areas where movement and vibration is experienced. The design allows a high degree of flexibility without the risk of crushing, creasing or splitting with the additional advantage of anti-Bacterial protection.

#### Features and Benefits

- Ideal solution for bundling, protecting and fixing cables
- Quick and easy to apply
- Good abrasion protection
- Special profile enables branching off cable at any point
- Can be removed and reapplied often
- Handy HAT applicator tool included
- Material - Polypropylene (PP)
- Black as standard (other colours available on request)
- Reel length 25m

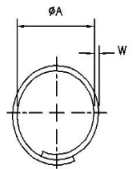
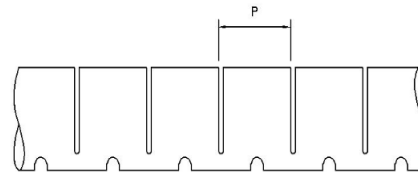

TYPE	Bundle Dia Max	Nominal Dimesions (mm)			Part Number
		A	W	P	
HWPPAB8	9.0	8.0	0.75	10.0	161-67100
HWPPAB16	16.0	14.0	0.80	13.0	161-67200
HWPPAB20	21.0	19.0	0.95	16.0	161-67300
HWPPAB25	27.0	24.0	1.05	20.0	161-67400
HWPPAB30	32.0	30.0	1.05	24.0	161-67500

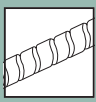

## Anti-Bacterial Spiral Binding

### SBPEAB/SBPAAB

Spiral Binding is a general-purpose solution for many bundling applications. It is used for organising and protecting cables and hoses.

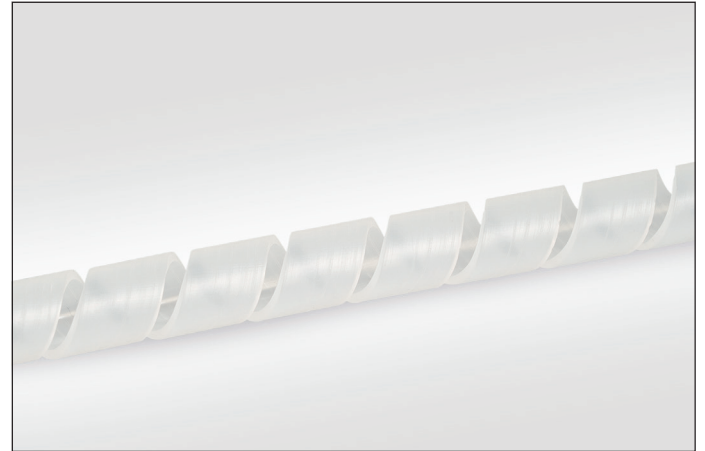

### Features and Benefits

- Organises and protects cables and hoses
- Suitable for retro-fitting
- Cables branch out at any point
- Very good protection against abrasion
- Material - Polyethylene (PE) or Nylon (PA6)
- Reel length 30m

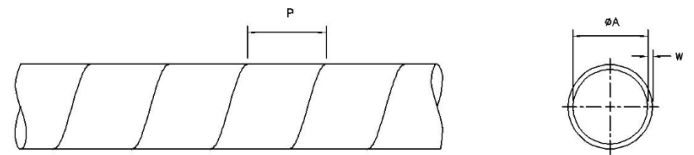

### Spiral Binding - Polyethylene

TYPE	Recommended Loom Size*	Colour	Nominal Dimesions (mm)			Part Number
			A	W	P	
SBPEAB1.5	1.5 - 8.0	Black	1.5	0.4	6.0	161-47000
SBPEAB4	5.0 - 20.0	Black	4.0	0.6	7.8	161-47100
SPBEAB6	7.5-40.0	Black	6.0	0.8	10.0	161-47150
SBPEAB9	10.0 - 100.0	Black	9.0	1.0	12.5	161-47200
SBPEAB16	20.0 - 150.0	Black	16.0	1.2	16.0	161-47300

### Spiral Binding - Nylon (PA6)

TYPE	Recommended Loom Size	Colour	Nominal Dimesions (mm)			Part Number
			A	W	P	
SBPAAB1.5	1.5 - 8.0	Natural	1.5	0.4	6.0	161-48000
SBPAAB4	5.0 - 20.0	Natural	4.0	0.6	7.8	161-48100
SBPAAB6	7.5 - 40.0	Natural	6.0	0.8	10.0	161-48150
SBPAAB9	10.0 - 100.0	Natural	9.0	1.0	12.5	161-48200
SBPAAB16	20.0 - 150.0	Natural	16.0	1.2	16.0	161-48300

\*Note that the product will provide protection and binding for a harness at the lower end of the loom size-range, but can only be recommended for binding at the upper end of the loom size-range.

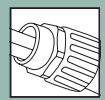

## Protective Tubing

### FCTAB Convuluted Tubing

The FCTAB range of flexible convoluted tubing is designed to provide strength and flexibility to protect cables when routed through areas where movement and vibration are experienced.

#### Features and Benefits

- Very flexible
- Protection from crushing
- Provides effective, orderly-looking protection
- Black as standard (other colours available on request)
- Material - Nylon (PA6)

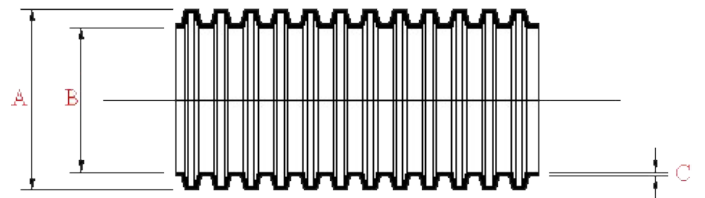
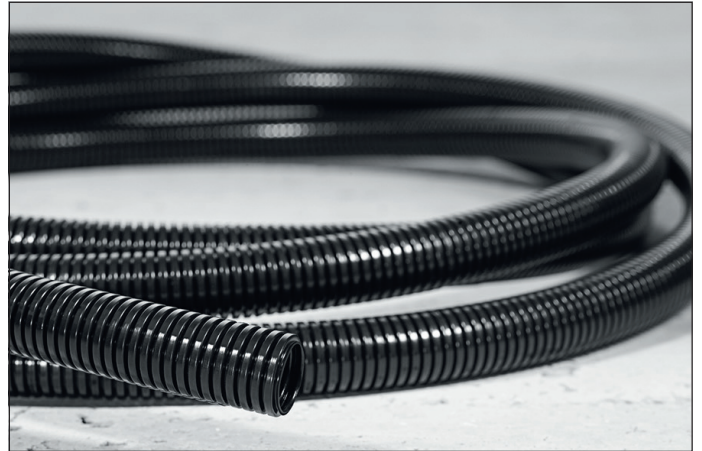

TYPE	Description	Nominal Dimensions (mm)			Reel Length	Part Number
		A	B	C		
FCTAB7	Standard	9.9	6.9	0.40	200m	169-00200
FCTAB10	Standard	14.0	10.5	0.45	200m	169-00210
FCTAB11	Standard	15.5	11.5	0.45	200m	169-00220
FCTAB13	Standard	17.3	12.1	0.45	200m	169-00230
FCTAB16	Standard	20.7	16.5	0.45	100m	169-00240
FCTAB19	Standard	23.5	19.5	0.45	50m	169-00250
FCTAB23	Standard	27.7	23.5	0.55	50m	169-00260



### Edge Protection

#### G51NAB Grommet Strip

Grommet Strip has a flexible “U” section designed to line irregular shaped holes through panels or bulkheads to prevent chafing of cables, pipes etc. G51NAB is manufactured from a high grade PA6 with Anti-Bacterial and abrasion resistance.



#### Features and Benefits

- Very flexible
- Easily and securely applied without adhesives
- Provides effective, orderly-looking protection
- Natural as standard (other colours available on request)
- Material - Nylon (PA6)

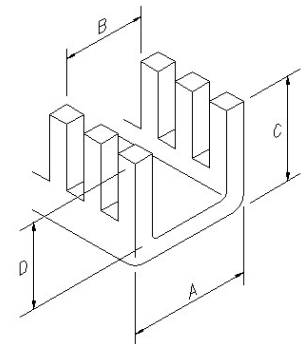

TYPE	Panel Thickness	Colour	Nominal Dimensions (mm)				
			A	B	C	D	Part Number
G51NABA	0.4 - 1.3	Natural	3.9	1.5	4.3	2.7	251-22100
G51NABB	1.3 - 2.1	Natural	4.6	2.4	4.3	2.7	251-22200
G51NABC	2.1 - 3.3	Natural	5.7	3.5	4.3	2.7	251-22300
G51NABD	3.3 - 4.8	Natural	8.4	5.1	6.2	4.3	251-22400
G51NABE	4.8 - 6.5	Natural	9.9	6.7	6.4	4.5	251-22500
G51NABF	6.5 - 8.1	Natural	11.4	8.3	6.8	4.8	251-22600
G51NABG	8.1 - 9.7	Natural	13.2	10.1	6.8	4.8	251-22700



HellermannTyton is characterised as being a “hands-on” organisation. Our Product Management team’s primary objective is to provide both internal and external customers with technical support on HellermannTyton’s ever expanding range of products.

We want to ensure that HellermannTyton has the right products for you our customer, and you know everything about them.

We are not only open for business, but we are also here to help you find solutions, solve problems and support the needs of your business.

Our philosophy has always been “Our Customer is Our Priority”.

Please feel free to contact us with any element of support you need, whether it is help with product knowledge, finding a new product to fix a problem or to simply share your ideas on how we can help you more.

## Contact our team and take advantage of our expertise

HellermannTyton Cannock  
Cley Road  
Kingswood Lakeside  
Cannock  
WS11 8AA  
0808 164 2004  
[UK-HTDC@HellermannTyton.com](mailto:UK-HTDC@HellermannTyton.com)

