



Greener alternatives to PA66 in your cable management

Cable ties, clips and mounts manufactured from PP, PA11 and PLA

MADE FOR REAL 

Changing the status quo – and for good reason

A material step to lowering the carbon footprints of parts

Polyamide 6.6 (PA66/nylon) has become the most commonly used engineering plastic for making cable management components. However, its relative carbon equivalent is higher than other polymers.

At HellermannTyton, we are implementing ways to help you lower the relative CO₂ footprint of the parts we manufacture for your applications.

Greener options for black and white parts

We have the experience and know-how to design and produce fixing ties, clips and mounts for your wire management from plastic materials that have a lower impact on the environment.

For example, the carbon footprint of the polypropylene (PP) parts listed in this brochure is 75% lower than nylon-based equivalents, and it is well-suited to recycling and re-use in circular economies.

Plastics derived from renewable resources, like polyamide 11 (PA11) and polylactic acid (PLA), or recyclates blended with virgin material, are also worthy contributors to the achievement of sustainability targets.



More on alternatives to PA66



Polypropylene (PP)

Cable Ties

PART DESCRIPTION	Image	Bundle Ø min.	Bundle Ø max.	
Cable ties, inside serrated				
ESD100-PPCOND-BK		5.0	22.0	50 N
ESD200-PPCOND-BK		8.0	50.0	150 N
T120I-PP-NA		4.8	80.0	270 N
T120R-PP-BK		9.0	104.0	270 N
T120S-PP-NA		5.0	55.0	270 N
T18R-PP-BK		1.5	22.0	65 N
T18R-PP-NA		3.0	22.0	65 N
T30L-PP-NA		1.5	50.0	105 N
T30R-PP-NA		1.5	35.0	105 N
T50I-PP-BK		6.0	85.0	135 N
T50I-PP-NA		6.0	85.0	135 N
T50L-PP-NA		16.0	110.0	135 N
T50R-PP-BK		1.5	50.0	135 N



Polypropylene (PP)

Cable Ties

PART DESCRIPTION	Image	Bundle Ø min.	Bundle Ø max.	
T50R-PP-NA		3.0	50.0	135 N
T50R-PPW-BK		8.0	50.0	179 N
T60S-PPW-BK		14.0	65.0	224 N
Cable ties, releasable				
RF250-PP-NA		2.5	72.0	147 N
RF250-PPW-BK		2.5	72.0	147 N
TEXTIE L-PA66/PP-BK		-	100.0	-
TEXTIE M-PA66/PP-BK		-	60.0	-
TEXTIE M-PA66/PP-BU		-	60.0	-
TEXTIE M-PA66/PP-GN		-	60.0	-
TEXTIE M-PA66/PP-RD		-	60.0	-
TEXTIE M-PA66/PP-WH		-	60.0	-
TEXTIE M-PA66/PP-YE		-	60.0	-
TEXTIE S-PA66/PP-BK		-	45.0	-



Polypropylene (PP)



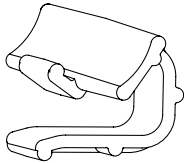

Fixing ties for holes

PART DESCRIPTION	Image	Bundle Diameter max (metric)	Panel Thickness	for Hole Ø (FH)
Fixing Tie, oval hole, arrow head, 1 piece				
T50S0SAH7X12U-PP-NA		50.0	0.6 - 3.6	7.0 x 12.0

Bundling Clips









PART DESCRIPTION	Image	Panel Thickness	Bundling Bar Length
Bundling Clip, edge, for hole			
TC58CIC-PP-BK		3.0 - 5.0	58.0

Products for wires and hoses

PART DESCRIPTION	Image	Bundle Diameter max (metric)	for Hole Ø (FH)	Stud Ø
Harness Clip, close, round hole, arrow head				
CDC10-13AH6.35-PP-BK		13.0	6.4	-
CDC10AH6.35-PP-BK		10.0	6.4	-
CDC25AH6.35-PP-GY		25.0	6.4	-
CDC9AH10.1-PP-GY		9.0	6.4	-









Polypropylene (PP)

Products for wires and hoses

PART DESCRIPTION	Image	Bundle Diameter max (metric)	for Hole Ø (FH)	Stud Ø
Harness Clip, close, round hole, fir tree				
CDC10-13B900S25FT6-PP-BK		13.0	6.6	-
CDC13FT6.35-PP-BK		13.0	6.4	-
CDC16B90FT6.68-PP-BK		16.0	6.7	-
CDC22FT6.35CC6-PP-GY		6.0	7.2	-
CDC25FT6.35-PP-BK		25.0	6.4	-
CDC25FT6.4CC5-PP-BK		25.0	6.4	-
CDC6FT6.35-PP-BK		6.0	6.4	-
CDC6FT7.63-PP-BK		6.0	6.4	-
CDC9FT6.35-PP-GY		9.0	6.4	-

Polypropylene (PP)

Products for wires and hoses

PART DESCRIPTION	Image	Bundle Diameter max (metric)	for Hole Ø (FH)	Stud Ø
Harness clip, close, screwable				
CDC10-13AM6-PP-BK		13.0	6.4	M6.0
CDC12AM6-PP-BK		12.0	6.4	M6.0
CDC6B90AOS8AM8-PP-BK		6.0	8.8	M8.0
CDC6B90O550.5M6-PP-BK		6.0	6.5	M6.0
CDC6S40.5M8-PP-BK		6.0	8.8	M8.0
Harness clip (2), closeable				
CDC10-16-PP-BK		16.0	-	-
Harness clip (2), open, close				
CDC6BC16-PP-BK		16.0	-	-
CDC6BC9-PP-BK		9.0	-	-



Polypropylene (PP)











Products for convoluted tubes

PART DESCRIPTION	Image	Bundle Diameter max (metric)	for Hole Ø (FH)	Stud Ø
Harness Clip, close, round hole, arrow head				
CDC10-13AH6.35-PP-BK		13.0	6.4	-
CDC10AH6.35-PP-BK		10.0	6.4	-
CDC25AH6.35-PP-GY		25.0	6.4	-
CDC9AH10.1-PP-GY		9.0	6.4	-
Harness Clip, close, round hole, fir tree				
CDC10-13B90OS25FT6-PP-BK		13.0	6.6	-
CDC13FT6.35-PP-BK		13.0	6.4	-
CDC16B90FT6.68-PP-BK		16.0	6.7	-
CDC22FT6.35CC6-PP-GY		6.0	7.2	-
CDC25FT6.35-PP-BK		25.0	6.4	-
CDC25FT6.4CC5-PP-BK		25.0	6.4	-



Polypropylene (PP)

Products for convoluted tubes

PART DESCRIPTION	Image	Bundle Diameter max (metric)	for Hole Ø (FH)	Stud Ø
CDC6FT6.35-PP-BK		6.0	6.4	-
CDC6FT7.63-PP-BK		6.0	6.4	-
CDC9FT6.35-PP-GY		9.0	6.4	-
Harness clip, close, screwable				
CDC10-13AM6-PP-BK		13.0	6.4	M6.0
CDC12AM6-PP-BK		12.0	6.4	M6.0
CDC6B90AOS8AM8-PP-BK		6.0	8.8	M8.0
CDC6B90OS50.5M6-PP-BK		6.0	6.5	M6.0
CDC6S40.5M8-PP-BK		6.0	8.8	M8.0
Harness clip (2), closeable				
CDC10-16-PP-BK		16.0	-	-
Harness clip (2), open, close				
CDC6BC16-PP-BK		16.0	-	-
CDC6BC9-PP-BK		9.0	-	-



Polypropylene (PP)

Products to screw

PART DESCRIPTION	Image	for Hole Ø (FH)	Bundle Diameter max (metric)	Mounting Screw Type
Harness clip, close, screwable				
CDC10-13AM6-PP-BK		6.4	13.0	M6.0 Screw
Mount, screwable, 2 ties				
CTAM1-PPCOND-BK		4.4	-	M4.0 Screw
KR6G5-PP-BK		4.5	-	M4.0 Screw

Plugs (blind, cover, open)

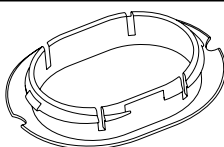

PART DESCRIPTION	Image	Panel Thickness	for Hole Ø (FH)
Plug, edges			
Open Plug 55x70-PP-BK		5.0 - 8.0	55.0 x 70.0

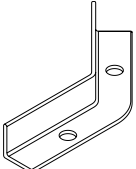
Cable Channels

PART DESCRIPTION	Image	for Hole Ø (FH)	Length (L)	Height (H)	Angle
150STRTCHNL-PPTD20-BK		6.2 - 6.8	150.0	15.0	180 °
45MINICHNL2-PPTD20-BK		6.1 - 6.9	89.7	15.0	45 °

Polypropylene (PP)

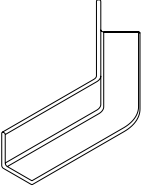
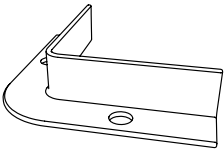
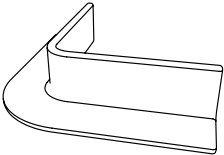
Cable Channels

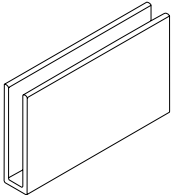
PART DESCRIPTION	Image	for Hole Ø (FH)	Length (L)	Height (H)	Angle
45MINICHNL-PPTD20-BK		-	52.0	10.0	45 °
90MINICHNL2-PPTD20-BK		6.4 - 6.7	63.5	15.0	90 °
90MINICHNL-PPTD20-BK		-	38.5	10.0	90 °
90RADMINICHNL-PPTD20-BK		6.3 - 6.8	59.5	1.75	90 °
MINICHNLU-PPTD20-BK		-	50.0	30.0	180 °



Polypropylene (PP) + Polyamide 66 (PA66HIRHS)

Fixing ties for holes

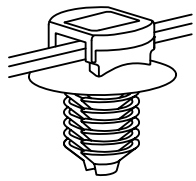
PART DESCRIPTION	Image	Bundle Diameter max (metric)	Panel Thickness	for Hole Ø (FH)
Fixing Tie, round hole, fir tree, 2 pieces				
T50RFT6LG-PP/PA66HIRHS-BK		45.0	0.8 - 6.0	6.4 - 7.1

Edge fixation products

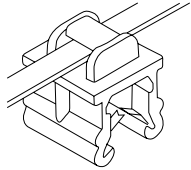
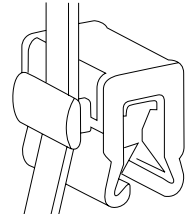
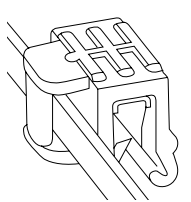
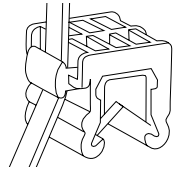
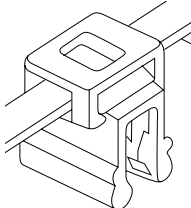
PART DESCRIPTION	Image	Panel Thickness	Bundle Diameter max (metric)
Edge Clip, cable tie, 2 pieces			
T50REC20-PP/PA66HIRHS-BK		3.0 - 6.0	45.0
T50REC21-PP/PA66HIRHS-BK		1.0 - 3.0	45.0
T50REC22-PP/PA66HIRHS-BK		1.0 - 3.0	50.0
T50REC23-PP/PA66HIRHS-BK		3.0 - 6.0	45.0
T50REC4A-PP/PA66HIRHS-BK		1.0 - 3.0	45.0

Polyamide 11 (PA11)

Cable Ties



PART DESCRIPTION	Image	Bundle Ø min.	Bundle Ø max.	 N
Cable ties, inside serrated				
GL100-PA11W-BK		1.0	22.0	80 N
GL150-PA11W-BK		1.5	36.0	130 N
GL200-PA11W-BK		1.5	50.0	200 N
GL250-PA11W-BK		1.5	65.0	250 N
GL300-PA11W-BK		7.0	80.0	250 N
GL380-PA11W-BK		7.0	105.0	200 N
GL460-PA11W-BK		15.0	130.0	480 N
GL600-PA11W-BK		15.0	175.0	480 N
T120L-PA11-BK		5.0	225.0	535 N
T120XM-PA11-BK		15.0	175.0	535 N
T18R-PA11-BK		1.5	22.0	80 N
T30R-PA11-BK		1.5	35.0	130 N
T50I-PA11-BK		1.5	85.0	225 N
T50M-PA11-BK		1.5	65.0	225 N
T50R-PA11-BK		1.5	50.0	170 N
T50S-PA11-BK		1.5	35.0	170 N
TBT150-PA11-CL		4.5	36.0	130 N
Cable ties, outside serrated				
LPH123-PA11-BK		4.0	22.0	310 N
Robusto (LPH922)-PA11-BK		4.0	22.0	310 N
Robusto (LPH942)-PA11-BK		10.0	42.0	360 N
Robusto (LPH962)-PA11-BK		25.0	62.0	530 N
Robusto (LPH992)-PA11-BK		25.0	92.0	530 N
Cable ties, releasable				
GLRF250-PA11W-BK		2.5	72.0	200 N

Polyamide 11 (PA11)

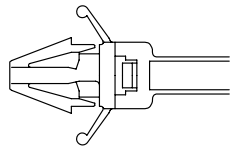

Fixing ties for holes

PART DESCRIPTION	Image	Bundle Diameter max (metric)	Panel Thickness	for Hole Ø (FH)
Fixing Tie, round hole, arrow head, 1 piece				
GLRT50RSF-PA11W-BK		48.0	1.0 - 2.6	6.0 - 7.5

Edge fixation products

PART DESCRIPTION	Image	Panel Thickness	Bundle Ø min.	Bundle Diameter max (metric)
Edge Clip, hose retainer, closeable				
GLEC1-2J-7-PA11W-BK		1.0 - 3.0	6.4	7.1
GLEC1-2VJ-7-PA11W-BK		1.0 - 3.0	6.4	7.1

Products for wires and hoses

PART DESCRIPTION	Image	Bundle Ø min.	Bundle Diameter max (metric)	Panel Thickness	for Hole Ø (FH)
Cable ties, inside serrated					
TBT150-PA11-CL		4.5	36.0	-	-
Edge Clip, hose retainer, closeable					
GLEC1-2J-7-PA11W-BK		6.4	7.1	1.0 - 3.0	-
GLEC1-2VJ-7-PA11W-BK		6.4	7.1	1.0 - 3.0	-



Polyamide 11 (PA11)



Products for wires and hoses

PART DESCRIPTION	Image	Bundle Ø min.	Bundle Diameter max (metric)	Panel Thickness	for Hole Ø (FH)
Harness Clip, close, round hole, arrow head					
HC721PM7-PA11W-BK		7.0	21.0	1.0 - 2.6	6.0 - 7.5

Products to screw



PART DESCRIPTION	Image	for Hole Ø (FH)	Bundle Diameter max (metric)	Mounting Screw Type
Fixing Tie, screwable				
T50MR-PA11-CL		5.2	50.0	M5.0 Screw

Cable Tie Accessory

PART DESCRIPTION	Image	Panel Thickness	Length (L)	Length (L2)	for Hole Ø (FH)
Mount for hole (round), cable tie retainer					
GLPM7-PA11W-BK		1.0 - 2.6	8.6	-	6.0 - 7.5
LOK01-PA11-BK		-	44.0	6.5	7.0 - 8.0

Poly lactide (PLA)

Cable Ties

PART DESCRIPTION	Image	Bundle Ø min.	Bundle Ø max.	 N
Cable ties, inside serrated				
BDG100-PLA-WH		4.0	22.0	80 N
BDG150-PLA-WH		5.0	36.0	130 N
BDG200-PLA-WH		6.0	50.0	200 N
BDG250-PLA-WH		12.0	65.0	250 N

Europe

 **HellermannTyton GmbH – Austria**
Rennbahnweg 65
1220 Vienna
Tel.: +43 12 59 99 55-0
Fax: +43 12 59 99 11
Email: office@HellermannTyton.at
www.HellermannTyton.at

 **HellermannTyton – Bulgaria**
Email: officeBG@HellermannTyton.at
www.HellermannTyton.bg

 **HellermannTyton – Czech Republic**
Email: officeCZ@HellermannTyton.at
www.HellermannTyton.cz

 **HellermannTyton – Denmark**
Industrivej 44A, 1.
4000 Roskilde
Tel.: +45 702 371 20
Email: htdk@HellermannTyton.dk
www.HellermannTyton.dk

 **HellermannTyton – Finland**
Äyritie 12 B
01510 Vantaa
Tel.: +358 9 8700 450
Email: myynti@HellermannTyton.fi
www.HellermannTyton.fi

 **HellermannTyton S.A.S. – France**
2 rue des Hêtres - CS 80543
78197 Trappes Cedex
Tel.: +33 1 30 13 80 00
Fax: +33 1 30 13 80 60
Email: info.htf@HellermannTyton.com
www.HellermannTyton.fr

 **HellermannTyton GmbH – Germany**
Großer Moorweg 45
25436 Tömesch
Tel.: +49 4122 701-0
Fax: +49 4122 701-400
Email: info@HellermannTyton.de
www.HellermannTyton.de

 **HellermannTyton KFT – Hungary**
Kisfaludy u. 13
1044 Budapest
Tel.: +36 1 369 4151
Fax: +36 1 369 4151
Email: officeHU@HellermannTyton.at
www.HellermannTyton.hu

 **HellermannTyton Ltd – Ireland**
Unit A5 Cherry Orchard
Business Park
Ballyfermot, Dublin 10
Tel.: +353 1 626 8267
Fax: +353 1 626 8022
Email: sales@HellermannTyton.ie
www.HellermannTyton.co.uk

 **HellermannTyton S.r.l. – Italy**
Via Visco, 3/5
35010 Limena (PD)
Tel.: +39 049 767 870
Fax: +39 049 767 985
Email: info@HellermannTyton.it
www.HellermannTyton.it

 **HellermannTyton B.V. – Belgium/Netherlands**
Vanadiumweg 11-C
3812 PX Amersfoort
Tel.: +31 33 460 06 90
Email (NL): info@HellermannTyton.nl
Email (BE): info@HellermannTyton.be
www.HellermannTyton.nl
www.HellermannTyton.be

 **HellermannTyton AS – Norway**
Nils Hansens vei 13
0667 Oslo
Tel.: +47 23 17 47 00
Email: firmapost@HellermannTyton.no
www.HellermannTyton.no

 **HellermannTyton Sp. z o.o. – Poland**
Kotunia 111
62-400 Słupca
Tel.: +48 63 2237 111
Fax: +48 63 2237 110
Email: info@HellermannTyton.pl
www.HellermannTyton.pl

 **HellermannTyton – Romania**
Email: officeRO@HellermannTyton.at
www.HellermannTyton.ro

 **OOO HellermannTyton – Russia**
40/4, Pulkovskoe road
BC Technopolis Pulkovo, office A 8081
196158, St. Petersburg
Tel.: +7 812 386 00 09
Fax: +7 812 386 00 08
Email: info@HellermannTyton.ru
www.HellermannTyton.ru

 **HellermannTyton – Slovenia**
Branch Office Ljubljana
Podružnica Ljubljana, Ukmarjeva 2
1000 Ljubljana
Tel.: +386 1 433 70 56
Fax: +386 1 433 63 21
Email: officesl@HellermannTyton.at
www.HellermannTyton.si

 **HellermannTyton España s.l. – Spain / Portugal**
Avda. de la Industria 37 2º 2º
28108 Alcobendas, Madrid
Tel.: +34 91 661 2835
Email:
HellermannTyton@HellermannTyton.es
www.HellermannTyton.es

 **HellermannTyton AB – Sweden**
Isafjordsgatan 5
16440 Kista
Tel.: +46 8 580 890 00
Fax: +46 8 580 348 02
Email: kundsupport@HellermannTyton.se
www.HellermannTyton.se

 **HellermannTyton Engineering GmbH – Turkey**
Saray Mah Dr. Adnan Büyükdenez Cad. No:4
Akkom Office Park 2. Blok Kat: 10
34768 Ümraniye-Istanbul
Tel.: +90 216 687 03 40
Fax: +90 216 250 32 32
Email: info@HellermannTyton.com.tr
www.HellermannTyton.com.tr

 **HellermannTyton Ltd – UK**
William Prance Road
Plymouth International Medical
and Technology Park
Plymouth, Devon PL6 5WR
Tel.: +44 1752 701 261
Fax: +44 1752 790 058
Email: uk-pt@HellermannTyton.com
www.HellermannTyton.co.uk

 **HellermannTyton Ltd – UK**
Sharston Green Business Park
1 Robeson Way
Altrincham Road, Wythenshawe
Manchester M22 4TY
Tel.: +44 161 947 2200
Fax: +44 161 947 2220
Email: uk-pt@HellermannTyton.com
www.HellermannTyton.co.uk

 **HellermannTyton Ltd – UK**
Cley Road, Kingswood Lakeside
Cannock, Staffordshire
WS11 8AA
Tel.: +44 1543 728282
Fax: +44 1543 728284
Email: uk-pt@HellermannTyton.com
www.HellermannTyton.co.uk

 **HellermannTyton Data Ltd – UK**
Waterside House, Edgar Mobbs Way
Northampton NN5 5JE
Tel.: +44 1604 707 420
Fax: +44 1604 705 454
Email: sales@htdata.co.uk
www.htdata.co.uk

Middle East

 **HellermannTyton – UAE**
Email: info@HellermannTyton.ae
www.HellermannTyton.ae

North America

 **HellermannTyton – Canada**
Tel.: +1 905 726 1221
Fax: +1 905 726 8538
Email: sales@HellermannTyton.ca
www.HellermannTyton.ca

 **HellermannTyton – Mexico**
Tel.: +52 333 133 9880
Fax: +52 333 133 9861
Email: info@HellermannTyton.com.mx
www.HellermannTyton.us

 **HellermannTyton – USA**
Tel.: +1 414 355 1130
Fax: +1 414 355 7341
Email: corp@htamericas.com
www.HellermannTyton.us

South America

 **HellermannTyton – Argentina**
Tel.: +54 11 4754 5400
Fax: +54 11 4752 0374
Email: ventas@HellermannTyton.com.ar
www.HellermannTyton.com.ar

 **HellermannTyton – Brazil**
Tel.: +55 11 4815 9000
Fax: +55 11 4815 9030
Email: vendas@HellermannTyton.com.br
www.HellermannTyton.com.br

Asia-Pacific

 **HellermannTyton – Australia**
Tel.: +61 2 9525 2133
Fax: +61 2 9526 2495
Email: cservice@HellermannTyton.com.au
www.HellermannTyton.com.au

 **HellermannTyton – China**
Tel.: +86 510 8528 2536
Fax: +86 510 8528 2731
Email: cservice@HellermannTyton.com.cn
www.HellermannTyton.com.cn

 **HellermannTyton – Hong Kong**
Tel.: +852 2831 9090
Fax: +852 2832 9381
Email: cservice@HellermannTyton.com.hk
www.HellermannTyton.com.sg

 **HellermannTyton – India**
Tel.: +91 120 413 3384
Email: cservice@HellermannTyton.co.in
www.HellermannTyton.co.in

 **HellermannTyton – Japan**
Tel.: +81 3 5790 3111
Fax: +81 3 5790 3112
Email: mkt@hellermanntyton.co.jp
www.HellermannTyton.co.jp

 **HellermannTyton – Republic of Korea**
Tel.: +82 32 833 8012
Fax: +82 32 833 8013
Email: cservice@HellermannTyton.co.kr
www.HellermannTyton.co.kr

 **HellermannTyton – Philippines**
Tel.: +63 2 752 6551
Fax: +63 2 752 6553
Email: cservice@HellermannTyton.com.ph
www.HellermannTyton.com.ph

 **HellermannTyton – Singapore**
Tel.: +65 6 586 1919
Fax: +65 6 752 2527
Email: cservice@HellermannTyton.sg
www.HellermannTyton.com.sg

 **HellermannTyton – Thailand**
Tel.: +662 237 6702 / 266 0624
Fax: +662 266 8664
Email: cservice@HellermannTyton.co.th
www.HellermannTyton.com.sg

Africa

 **HellermannTyton – South Africa**
Tel.: +27 11 879 6600
Fax: +27 11 879 6603
Email: jhb.sales@Hellermann.co.za
www.HellermannTyton.co.za